

RESIDENTIAL (32' F-F)

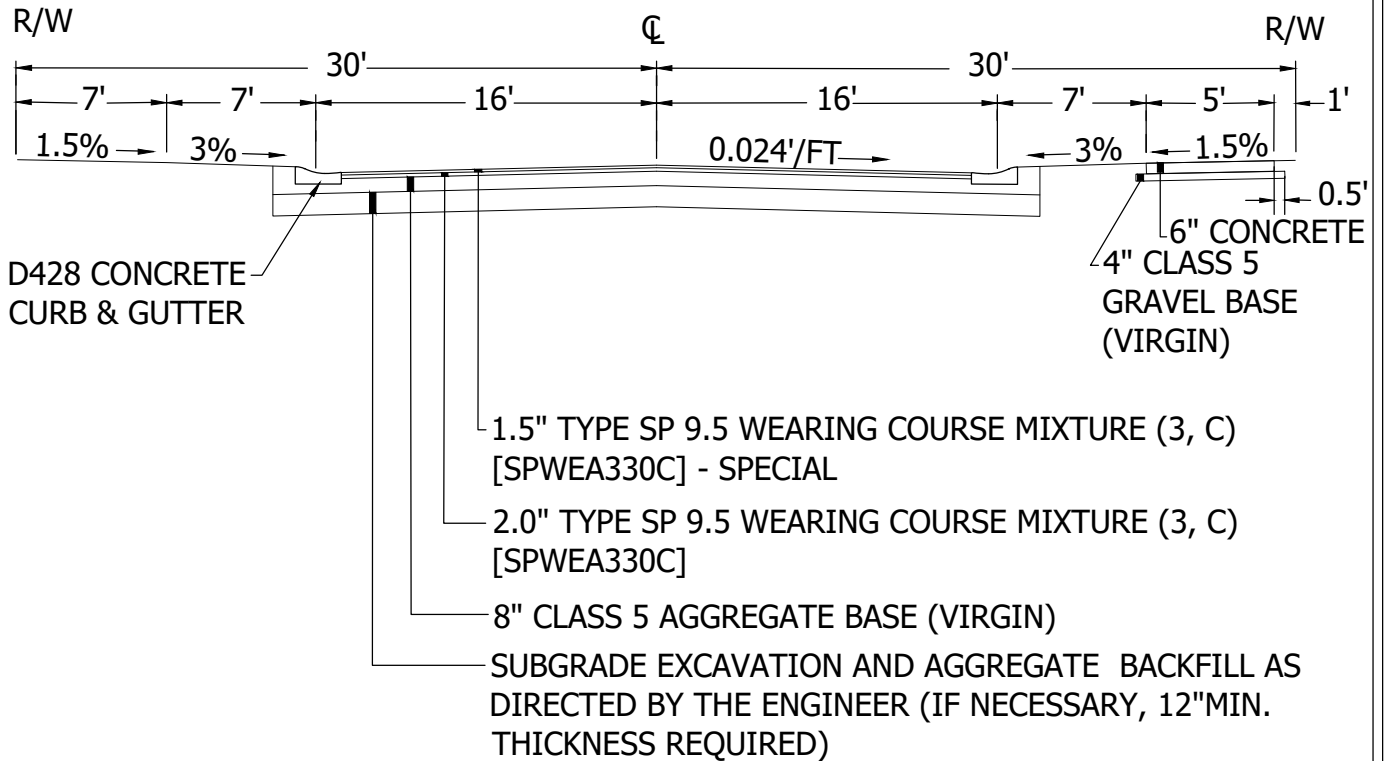

NOTES:

1. TOP OF D428 CURB IS 0.08 BELOW DESIGN CL GRADE.
2. R.O.W. TO BE 0.19' ABOVE DESIGN CL ELEVATION.



STANDARD DETAILS
TYPICAL PUBLIC STREET SECTION
RESIDENTIAL (32' F-F)
COTTAGE GROVE, MINNESOTA

JANUARY 2021

PLATE NO.
STR-2